

ER14505M 3.6V 2000MAH Specification sheet

HIGH POWER TYPE

Basic Specification

Nominal capacity (at 4.0mA, 23±2°C 2.0V)	2000mAh
Nominal voltage	3.6V
Standard discharge current	4.0mA
Maximum continuous current	400mA
Maximum pulse current	800mA
Self Discharge Rate	≤1% per year
Operating temperature range	-55°C~+85°C
Storage temperature (recommended)	10°C~+40°C
Max. dimensions (mm)	Φ14.5×50.5
Weight	19g

Mechanical Dimension

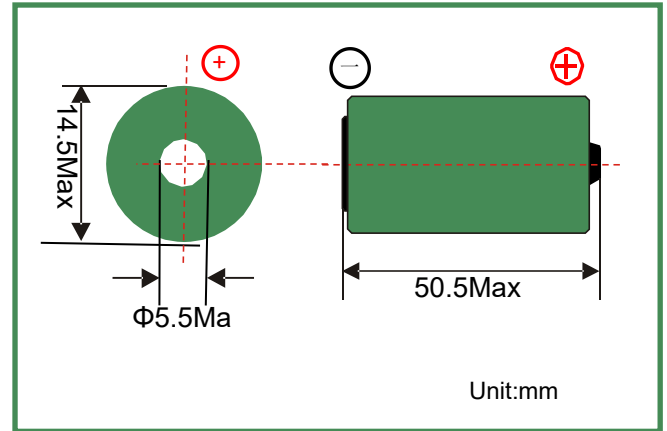

Electrical Characteristics

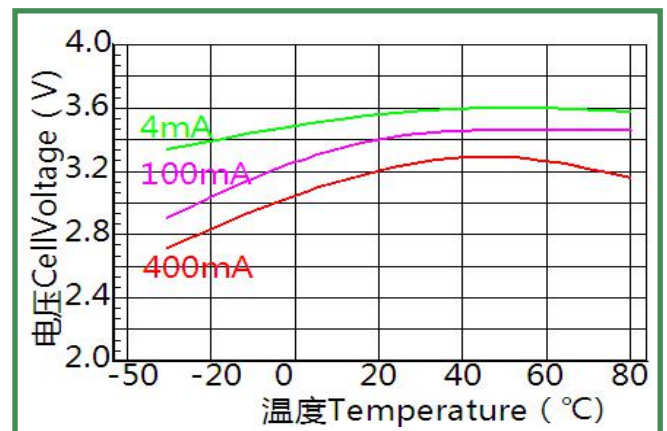
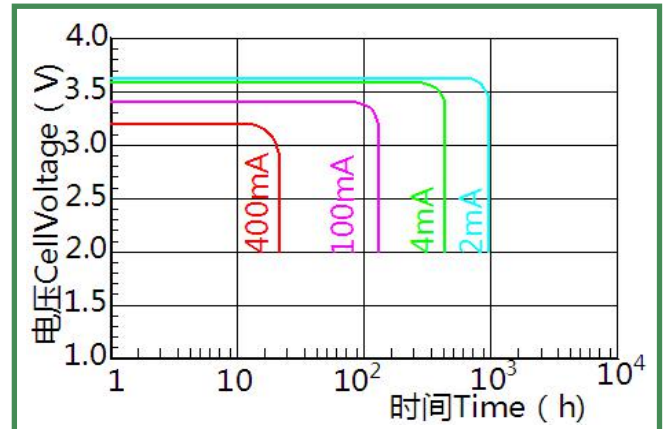

Main Features

- Spiral electrode structure ensures high discharge current
- High stable discharge characteristics
- Low self-discharge rate < 1% at 25°C and long shelf life more than 10 years
- Wide temperature range: -55°C~+85°C
- High voltage, with open circuit voltage 3.65V
- Wide load range, provide multiple pulse or heavy current pulse.
- CE, FCC ROHS approved

Main Applications

- Intelligent IC Meter
- Gas/water Meter
- Marine equipments (Pinger, life rescue devices)
- Portable GPS devices
- Smoke alarm, communication devices, etc.

Notes

- Special terminations can be added
- T: Solder tabs
- P: Axial pins

It is Lithium primary battery, can not be charged.

Please use battery under the temperature range listed in specification sheet.

Website: www.jzbattery.com

A ISO 9001:2008 certified company